

TECHNICAL COUNSELING FAQ

Here are some of the questions we have contacted the Tool Consultation.

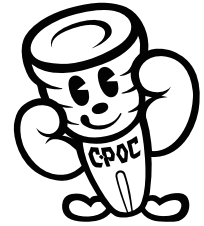

HOLDING MARK

Q When the tool is used after re-grinding, crescent-shaped marks will show on the workpiece.

A The following are generally considered as causes of marks on the upper and lower surfaces of the workpiece.

1. The end face of the die or guide is not flat.
When re-grinding dies, guides and strippers, the die may not be set properly on the grinder and the end face may be inclined. (See Fig.2)

Fig.1 Holding mark

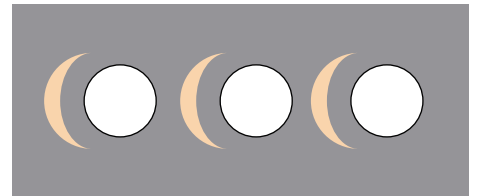

2. When the die is mounted, foreign matter (such as burrs) sticks on the bottom of the die, and the die is not properly installed. (See Fig.3)

When attaching a die to the die holder, it is recommended to clean not only the bottom of the die holder but also the area around it.

Fig.2 Die sharpened slantingly
slanting

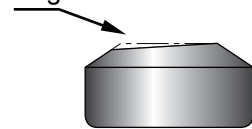

3. Up forming die has installed near standard tool station.

Up forming die are usually designed at higher die heights than standard dies. Therefore, if punching is performed near the up forming die, the material may be deformed and marked as shown in Fig.4.

In such a case, remove the high-height die at the periphery before processing. Also, depending on processing conditions, low height die can be prepared by Conic, so please contact us.

Fig.3 Die installed on slugs

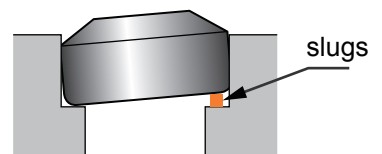
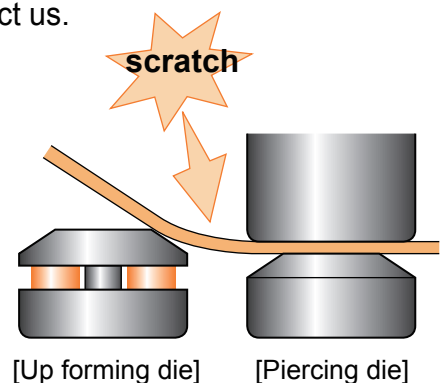

Fig.4 If piercing near the station where up forming die installed...



TECHNICAL COUNSELING FAQ

SHEET DISTORTION WHEN EMBOSS FORMING

Q Although embossing is performed, the workpiece warps (distorts). Is there a good way to prevent warping?

A A high rise embossed forming causes the material to warp and generate distortion. As a countermeasure,

1. In the case of upward forming, by using heavy duty die for the lower die to increase the force to hold the workpiece and suppress distortion.

(Some machines cannot be fitted with the heavy duty type die. Please check it before use it.)

Also, by using a station of one size larger, the plate pressing force is strengthened to suppress distortion.

2. Pre-piercing before forming step.

By pre-piercing before forming, distortion is reduced. In addition, if possible in the product, by pre-piercing around the, it is possible to suppress the distortion of the material.

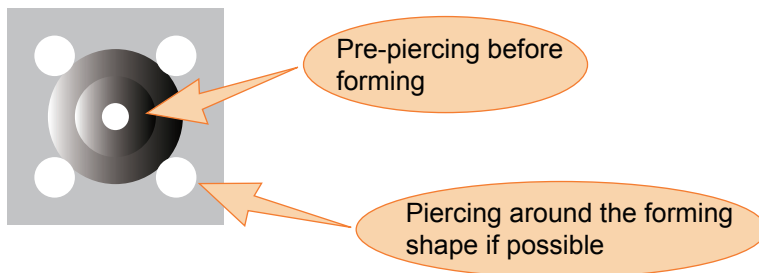

3. It is recommended to perform frame removal after embossing for distortion generated when processing near the material end face. We also offer tools that can be frame removing without crushing the embossing that was processed earlier.

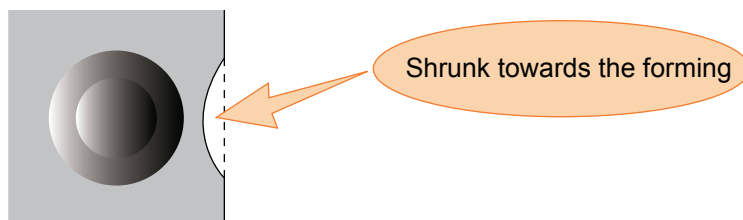
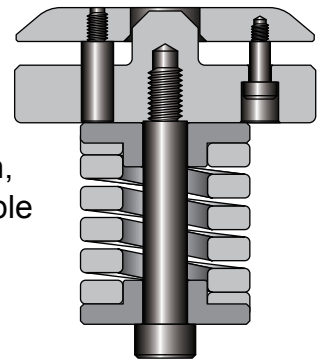
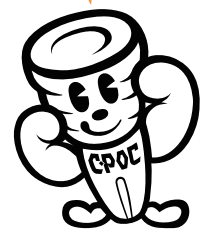

Fig.5 Heavy duty type die



The heavy duty die set is a type that strengthens the plate holding force and the strip force.



For More information,
please contact
CONIC tool sales desk.

CONIC Co., Ltd.

10-5 Taiheidai, Shoo-cho, Katsuta-gun,
Okayama 709-4321 Japan
Email: tools@conic.co.jp
https://www.conic.co.jp

CONIC PRECISION Co., Ltd.

55/22 Moo 4, Buengkumproy, Lumlukka,
Phatumthani 12150 Thailand
TEL: (662) 159-9870 FAX: (662) 159-9872
Email: conic_thai@conic.co.jp